

Top

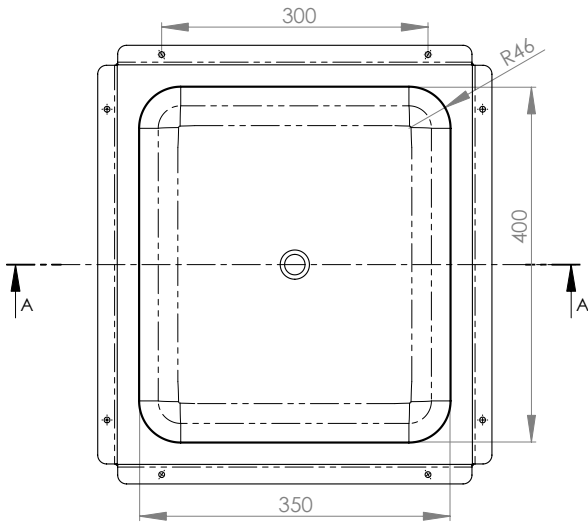

Side

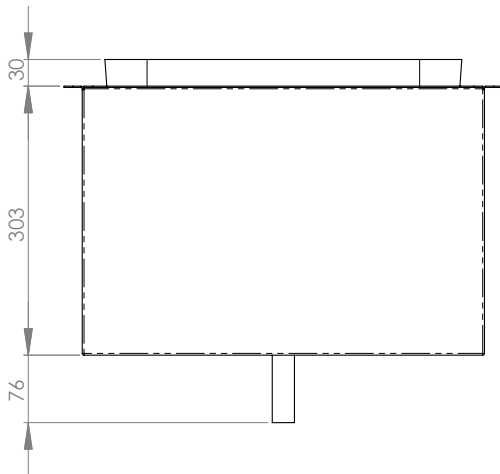

Cross-section A-A

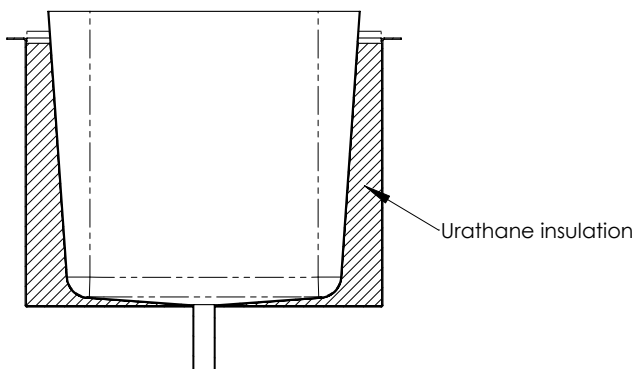

Product Code:

ICE-403530

This 3monkeez® pre-fabricated ice well comes supplied as a complete unit that is ready to weld in, and can be installed as a raised wet area or flush with the bench top.

Features and Benefits:

- Internal skin – constructed from 1.2mm 304 grade stainless steel
- External skin – constructed from 1.2mm 304 grade stainless steel complete with a flange for fixing
- Radius corners and cross breaks to a 25mm centre waste
- Raw edge ready for welding
- 25mm urethane injected insulation
- In stock and available for immediate delivery

Unit 6, 24 Wellington Street, Riverstone NSW 2765

Tel: 02 9627 6111 Fax: 02 9627 3111

sales@3monkeez.com.au

www.3monkeez.com.au

Details accurate at time of print. It is possible that some details may change without notice. Whilst all care has been taken in compiling this information, designs & dimensions shown are indicative only and should not be relied upon without prior approval.



another great idea.